



Schwäbisch-alemannische Fasnet in Rottenburg
Swabian-Alemannic Fasnet in Rottenburg
Souabe-alémanique Fasnet à Rottenburg

Maschinenschraubstöcke
Machine vices
Vices de la machine





Präzisionsschraubstöcke

Precision vices
Étaux de précision

- ❶ Einzigartiges Spannbacken-System zur Erhöhung der Spannkraft
 - ❷ Das patentierte Anti-Lift-System garantiert eine problemlose Bearbeitung, ohne Anhub des Werkstückes
 - ❸ Spannkraft mit Hilfe von Rillenmarkierungen voreinstellbar
 - ❹ Durch den mechanischen Spannkraftverstärker kann auch während extremer Arbeiten am Werkstück eine konstant hohe Spannkraft von bis zu 6500 kg erzielt werden
 - ❺ Alle Verschleißteile sind gehärtet und geschliffen
- ❶ Unique clamping-jaw-system increases the clamping capacity
 - ❷ The new Anti-Lift mechanism ensures that the workpiece does not lift during operations
 - ❸ Clamping force preadjustable with the aid of graduation lines
 - ❹ The mechanical Booster ensures that during extreme operations a constant high clamping-force up to 6500 kg can be reached
 - ❺ All working parts are hardened and grinded

- ❶ Unique système de mâchoire de serrage pour l'augmentation de la tension du ressort
- ❷ Le nouveau mécanisme Anti-Lift assure un usinage sans problème et sans enlèvement de la pièce
- ❸ La tension du ressort ce fait par pré réglage avec marquage
- ❹ Le répéteur de la tension du ressort assure que durant un usinage extrême la tension reste constante jusqu'à 6500 kg
- ❺ Toutes les pièces d'usure sont trempées et meulées

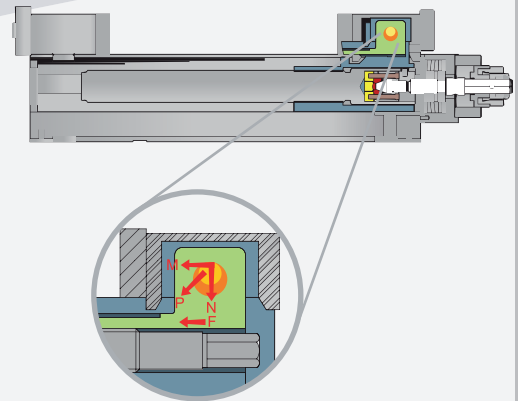

Durch das neue Anti-Lift-System werden die Werkstücke beim Spannen niedergezogen und präzise gespannt

By the new Anti-lift-system workpieces get pulled-down and precisely clamped

Par le nouveau système Anti-Lift les pièces sont baissées et serrées précisément

Allseitig gehärtet und geschliffen
All-round hardened and grinded
Complètement trempés et meulés

Stabiler Späneschutz
Solid chip protector
Protection résistant contre copeau

Spannkraft voreinstellbar
Clamping force preadjustable
Tension du ressort ajustable d'avance

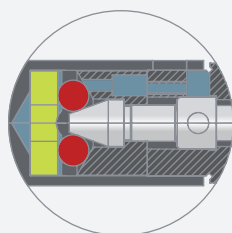
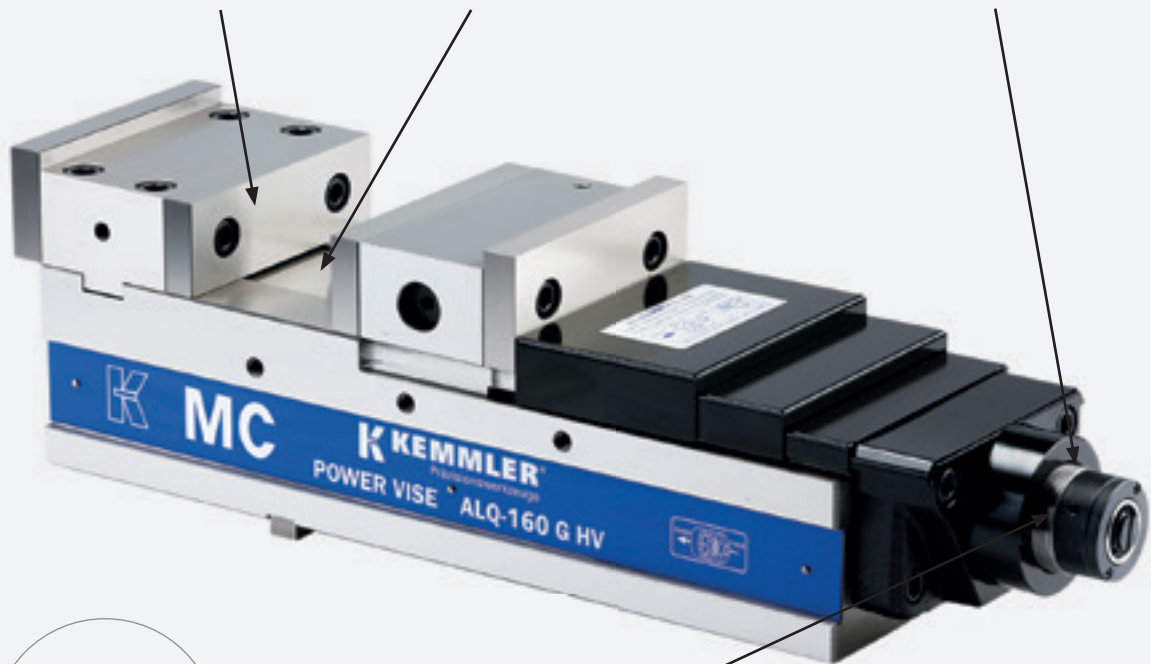

Mechanischer Spannkraftverstärker
Mechanical Booster
Répéteur de la tension du ressort

10

Inhaltsverzeichnis

Index

Sommaire



10.05



10.06

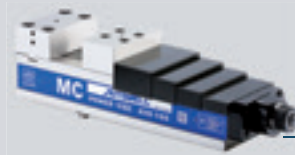

10.07



10.08

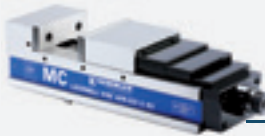

10.09



10.10



10.11



10.12



10.13



10.14



10.15



10.16

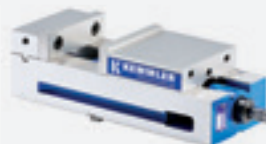

10.17



10.18



10.19



10.20



10.21



10.22

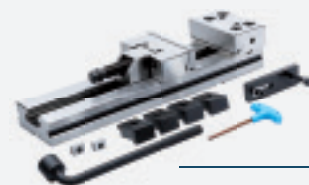

10.23



10.25



10.27



10.29



10.30



10.30

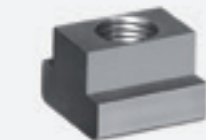

10.31



10.33



10.34



10

Präzisionserschraubstücke mechanisch mit Spannkraftverstärker

Precision vices mechanical with mechanical booster

Étaux de précision mécanique avec répéteur de la tension du ressort

Ausführung:

- Mit mechanischem Spannkraftverstärker
- Spannkraft voreinstellbar durch Rillenmarkierung
- Horizontal, vertikal oder seitlich aufspannbar
- Stahlkörper allseitig geschliffen und gehärtet
- Eingebauter Niederzug
- Betthöhe H: ≤ 0,01 mm

Lieferumfang:

- Bedienungsanleitung
- Incl. Spannschlüssel
- 4 Stück Spannpratzen
- 4 Stück T-Nutensteine 18mm
- Messprotokoll

Spannkraft:

KS01010 = 57 kN
KS01020 = 67 kN

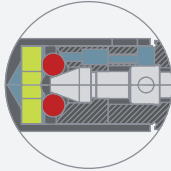
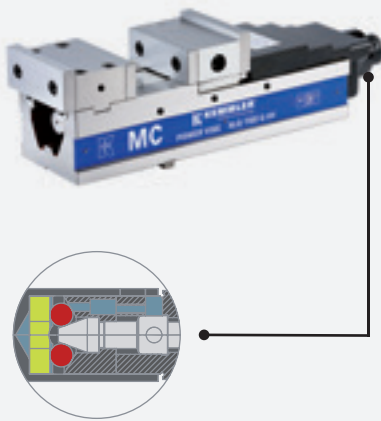

Mit patentiertem mechanischem Spannkraftverstärker:

- 1 kein Ölverlust
- 2 genaue Wiederholbarkeit der Spannkraft
- 3 keine Veränderung der Spannkraft
- 4 keine Vibrationen während der Bearbeitung
- 5 lange Lebensdauer

Construction:

- With mechanical booster
- Clamping force preadjustable by graduation lines
- Clamping positions: horizontal, vertical and lateral
- The steel body is hardened and grinded all-round
- Integrated pull-down mechanism
- Bed height H: ≤ 0,01 mm

Delivery:

- Instructions for use
- Wrench
- 4 pcs. vice clamps
- 4 pcs. T-nuts 18mm
- Test certificate

Clamping force:

KS01010 = 57 kN
KS01020 = 67 kN

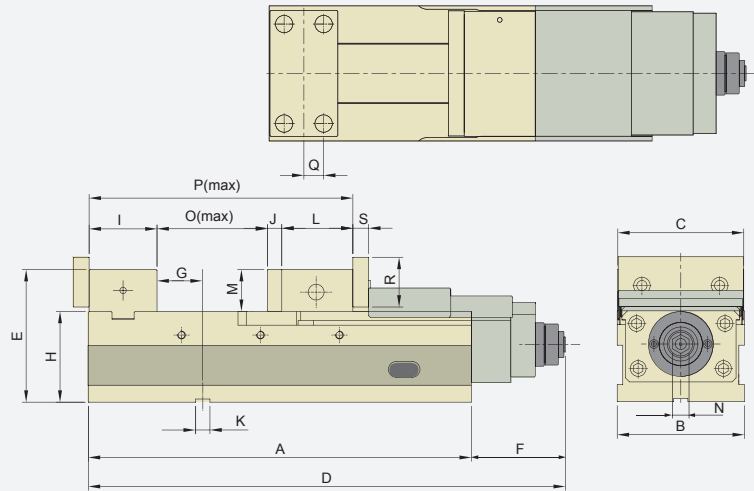
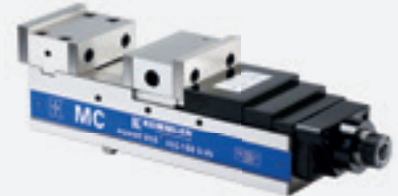

With patented mechanical booster:

- 1 no loss of oil
- 2 exact repeatability of the clamping force
- 3 constant clamping force
- 4 no vibrations during the operation
- 5 long life

Avec répéteur de la tension du ressort patenté:

- 1 pas de déchet d'huile hydraulique
- 2 répétabilité exacte de la tension du ressort
- 3 tension du ressort constante
- 4 pas de vibrations durant l'usage
- 5 durabilité longue

Bestell-Nr. Order no. Référence	Ausführung Version Type	A	B	C	D	E	F	G	H	I	J	K	L	M	N	O	P	Q	R	S	kN	kg
KS01010	ALQ-160G/HV	515	161	159,5	635	168	120	76	115	86	18	18	80	53	19	330,0	514,0	25	63	20	57	76
KS01020	ALQ-200G/HV	585	202	200,0	713	178	128	93	120	101	18	18	95	58	19	367,5	581,5	31	73	20	67	108

Präzisionsschraubstöcke mechanisch mit Spannkraftverstärker

Precision vices mechanical with mechanical booster

Étaux de précision mécanique avec répéteur de la tension du ressort



Ausführung:

- Mit mechanischem Spannkraftverstärker
- Spannkraft voreinstellbar durch Rillenmarkierung
- Horizontal, vertikal oder seitlich aufspannbar
- Stahlkörper allseitig geschliffen und gehärtet
- Eingebauter Niederzug
- Betthöhe H: $\leq 0,01$ mm

Lieferumfang:

- Bedienungsanleitung
- Incl. Spannschlüssel
- 4 Stück Spannpratzen
- 4 Stück T-Nutensteine 18mm
- Messprotokoll

Spannkraft:

KS02010 = 25 kN
 KS02020 = 35 kN
 KS02030 = 45 kN
 KS02040 = 50 kN

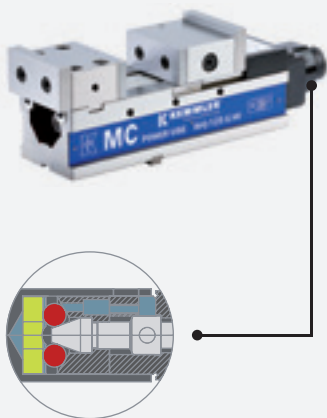

Construction:

- With mechanical booster
- Clamping force preadjustable by graduation lines
- Clamping positions: horizontal, vertical and lateral
- The steel body is hardened and grinded all-round
- Integrated pull-down mechanism
- Bed height H: $\leq 0,01$ mm

Delivery:

- Instructions for use
- Wrench
- 4 pcs. vice clamps
- 4 pcs. T-nuts 18 mm
- Test certificate

Clamping force:

KS02010 = 25 kN
 KS02020 = 35 kN
 KS02030 = 45 kN
 KS02040 = 50 kN

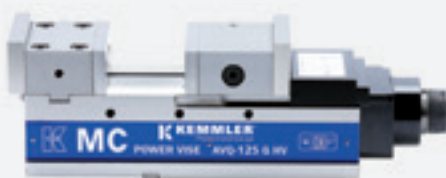

Type:

- Avec répéteur de la tension du ressort
- La tension du ressort ce fait par pré réglage avec marquage.
- Positions de serrage: horizontale, verticale ou latérale
- Corps en acier trempé et rectifié sur toutes les faces
- Répression basse incorporée
- Hauteur du socle H: $\leq 0,01$ mm

Livraison avec:

- Mode d'emploi
- Clé de serrage
- 4 Mors de serrage
- 4 Tasseaux pour rainures en T
- Protocole de mesure

Tension du ressort:

KS02010 = 25 kN
 KS02020 = 35 kN
 KS02030 = 45 kN
 KS02040 = 50 kN

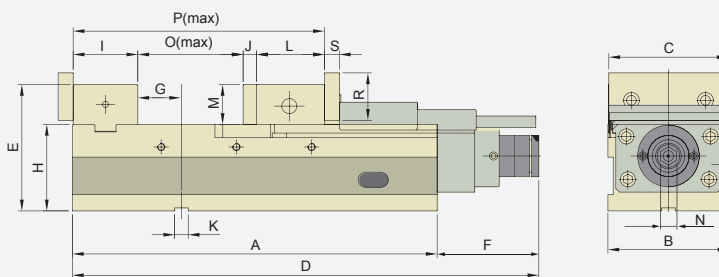
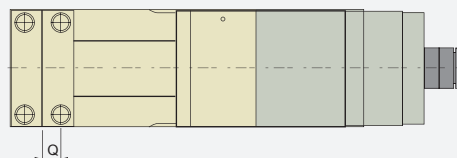

Mit patentiertem mechanischem Spannkraftverstärker:

- 1 kein Ölverlust
- 2 genaue Wiederholbarkeit der Spannkraft
- 3 keine Veränderung der Spannkraft
- 4 keine Vibrationen während der Bearbeitung
- 5 lange Lebensdauer

With patented mechanical booster:

- 1 no loss of oil
- 2 exact repeatability of the clamping force
- 3 constant clamping force
- 4 no vibrations during the operation
- 5 long life

Avec répéteur de la tension du ressort patenté:

- 1 pas de déchet d'huile hydraulique
- 2 répétabilité exacte de la tension du ressort
- 3 tension du ressort constante
- 4 pas de vibrations durant l'usinage
- 5 durabilité longue

Bestell-Nr. Order no. Référence	Ausführung Version Type	A	B	C	D	E	F	G	H	I	J	K	L	M	N	O	P	Q	R	S	kN	kg
KS02010	AVQ-100G/HV	324	104	102	428	130	104	41	85	73	15	18	86,5	45	14	140	314,5	20	55	17	25	30
KS02020	AVQ-125G/HV	390	127	125	495	153	105	66	100	78	15	18	87,5	53	14	201	381,5	22,5	63	20	35	46
KS02030	AVQ-160G/HV	485	161	159,5	605	168	120	58	115	86	18	18	80	53	14	295	479	25	63	20	45	71
KS02040	AVQ-200G/HV	535	202	200	655	178	128	75	120	101	18	18	95	58	14	320	534	31	73	20	50	100





Präzisionsschraubstöcke mechanisch mit Spannkraftverstärker

Precision vices mechanical with mechanical booster

Étaux de précision mécanique avec répéteur de la tension du ressort

Ausführung:

- Mit mechanischem Spannkraftverstärker
- Spannkraft voreinstellbar durch Rillenmarkierung
- Horizontal und vertikal aufspannbar
- Stahlkörper allseitig geschliffen und gehärtet
- Eingebauter Niederzug
- Bethöhe H: ≤ 0,01 mm

Lieferumfang:

- Bedienungsanleitung
- Incl. Spannschlüssel
- 4 Stück Spannpratzen
- 4 Stück T-Nutensteine 18mm
- Messprotokoll

Spannkraft:

KS14010 = 45 kN

Construction:

- With mechanical booster
- Clamping force preadjustable by graduation lines
- Clamping positions: horizontal and vertical
- The steel body is hardened and grinded all-round
- Integrated pull-down mechanism
- Bed height H: ≤ 0,01 mm

Delivery:

- Instructions for use
- Wrench
- 4 pcs. vice clamps
- 4 pcs. T-nuts 18mm
- Test certificate

Clamping force:

KS14010 = 45 kN

Type:

- Avec répéteur de la tension du ressort
- La tension du ressort ce fait par pré réglage avec marquage.
- Positions de serrage: horizontale ou verticale
- Corps en acier trempé et rectifié sur toutes les faces
- Répression basse incorporée
- Hauteur du socle H: ≤ 0,01 mm

Livraison avec:

- Mode d'emploi
- Clé de serrage
- 4 Mors de serrage
- 4 Tasseaux pour rainures en T
- Protocole de mesure

Tension du ressort:

KS14010 = 45 kN

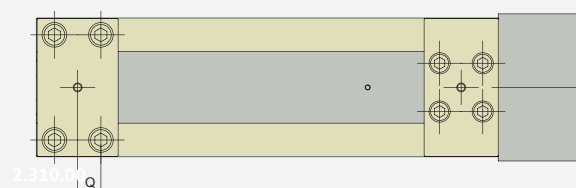
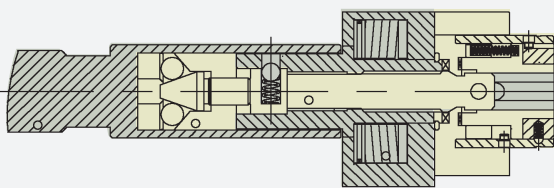
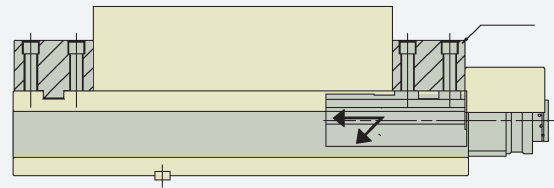
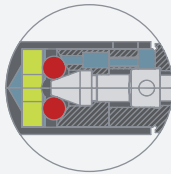
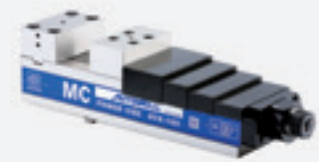

10



10.34



10.27

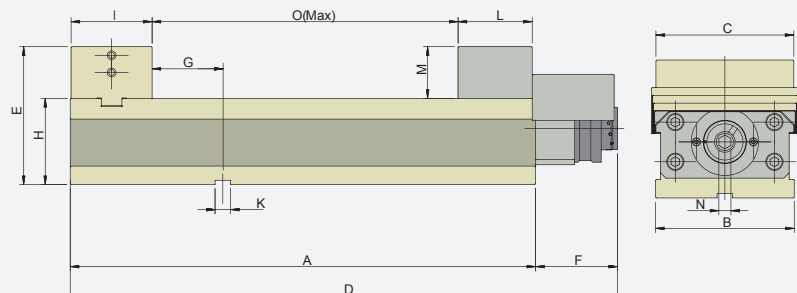

Bestell-Nr. Order no. Référence	Ausführung Version Type	A	B	C	D	E	F	G	H	I	K	M	N	O	Q	kN	kg
KS14010	AVK-160G/HV	540	161	160	635	160	95	82	100	94	18	60	14	355	27	45	65

Präzisionsschraubstöcke Zentrischspanner mechanisch

Precision vices self-centering mechanical

Étaux de précision etau autocentrant mécanique



Ausführung:

- Horizontal, vertikal oder seitlich aufspannbar
- Stahlkörper allseitig geschliffen und gehärtet
- Eingebauter Niederzug
- Betthöhe H: $\leq 0,01$ mm

Construction:

- Clamping positions: horizontal, vertical and lateral
- The steel body is hardened and grinded all-round
- Integrated pull-down mechanism
- Bed height H: $\leq 0,01$ mm

Type:

- Positions de serrage: horizontale, verticale ou latérale
- Corps en acier trempé et rectifié sur toutes les faces
- Répression basse incorporée
- Hauteur du socle H: $\leq 0,01$ mm

Lieferumfang:

- Bedienungsanleitung
- Incl. Spannschlüssel
- 4 Stück Spannpratzen
- 4 Stück T-Nutensteine 18mm
- Messprotokoll

Delivery:

- Instructions for use
- Wrench
- 4 pcs. vice clamps
- 4 pcs. T-nuts 18mm
- Test certificate

Livraison avec:

- Mode d'emploi
- Clé de serrage
- 4 Mors de serrage
- 4 Tasseaux pour rainures en T
- Protocole de mesure

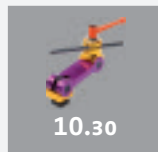
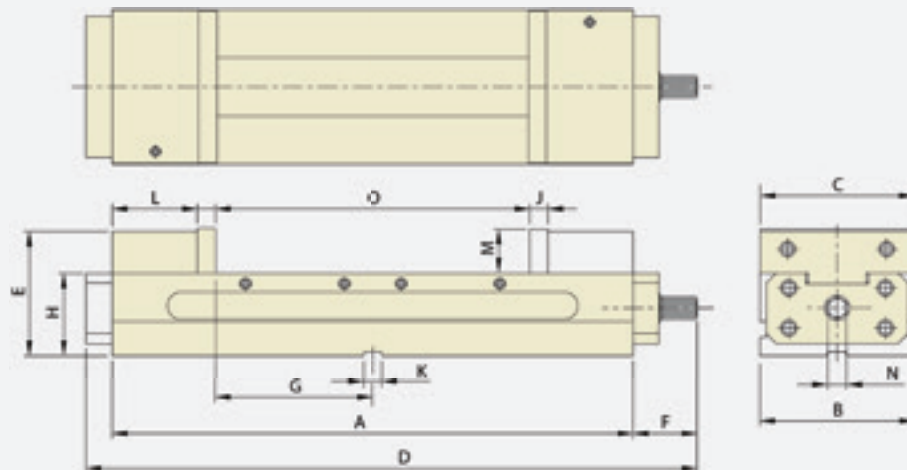
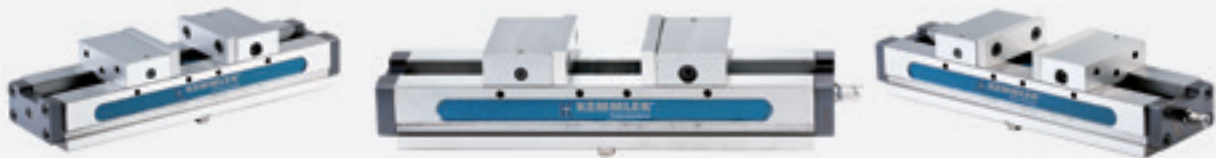

10



Bestell-Nr. Order no. Référence	Ausführung Version Type	A	B	C	D	E	F	G	H	J	K	L	M	N	O	T	U	kg
KS19010	HLD-60GG/HV	520	154	152	610	124,05	64	260	82,55	18	18	85	44,5	19	58-314	23,8	98,4	52



Präzisionsschraubstöcke mechanisch mit Spannkraftverstärker

Precision vices mechanical with mechanical booster

Étaux de précision mécanique avec répéteur de la tension du ressort

Ausführung:

- Mit mechanischem Spannkraftverstärker
- Spannkraft voreinstellbar durch Rillenmarkierung
- Horizontal, vertikal oder seitlich aufspannbar
- Stahlkörper allseitig geschliffen und gehärtet
- Eingebauter Niederzug
- Betthöhe H: $\leq 0,01$ mm

Lieferumfang:

- Bedienungsanleitung
- Incl. Spannschlüssel
- 4 Stück Spannpratzen
- 4 Stück T-Nutensteine 18mm
- Messprotokoll

Spannkraft:

KS15010 = 45 kN
KS15020 = 60 kN

Construction:

- With mechanical booster
- Clamping force preadjustable by graduation lines
- Clamping positions: horizontal, vertical and lateral
- The steel body is hardened and grinded all-round
- Integrated pull-down mechanism
- Bed height H: $\leq 0,01$ mm

Delivery:

- Instructions for use
- Wrench
- 4 pcs. vice clamps
- 4 pcs. T-nuts 18mm
- Test certificate

Clamping force:

KS15010 = 45 kN
KS15020 = 60 kN

Type:

- Avec répéteur de la tension du ressort
- La tension du ressort ce fait par préréglage avec marquage.
- Positions de serrage: horizontale, verticale ou latérale
- Corps en acier trempé et rectifié sur toutes les faces
- Répression basse incorporée
- Hauteur du socle H: $\leq 0,01$ mm

Livraison avec:

- Mode d'emploi
- Clé de serrage
- 4 Mors de serrage
- 4 Tasseaux pour rainures en T
- Protocole de mesure

Tension du ressort:

KS15010 = 45 kN
KS15020 = 60 kN

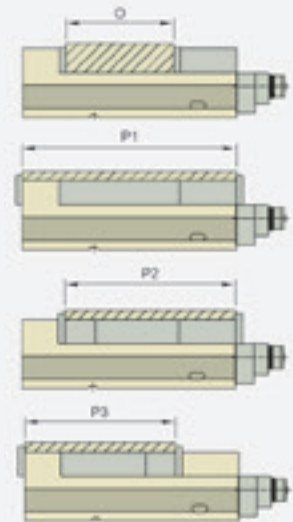
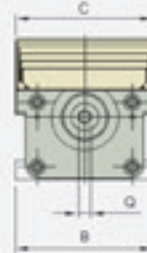
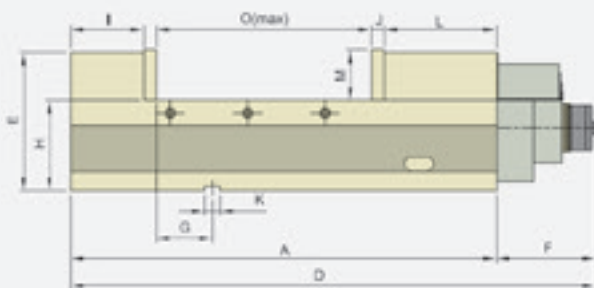
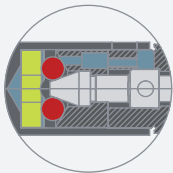
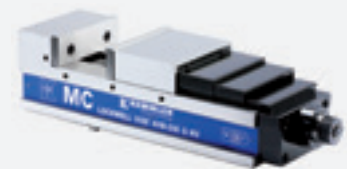

10

Bestell-Nr. Order no. Référence	Ausführung Version Type	A	B	C	D	E	F	G	H	I	J	K	L	M	N	O	P1	P2	P3	kN	kg
KS15010	AVM-160G/HV	495	161	160	610	160	115	65	105	85	15	18	130	58	19	250	250-480	250-370	250-330	45	55
KS15020	AVM-200G/HV	580	201	200	708	170	128	85	110	90	18	18	150	63	19	290	290-550	290-430	290-370	60	78

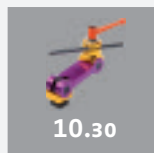
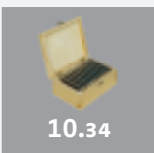

Präzisionsschraubstöcke mechanisch

Precision vices mechanical

Étaux de précision mécanique



Ausführung:

- Horizontal, vertikal oder seitlich aufspannbar
- Stahlkörper allseitig geschliffen und gehärtet
- Eingebauter Niederzug
- Betthöhe H: $\leq 0,01$ mm

Construction:

- Clamping positions: horizontal, vertical and lateral
- The steel body is hardened and grinded all-round
- Integrated pull-down mechanism
- Bed height H: $\leq 0,01$ mm

Type:

- Positions de serrage: horizontale, verticale ou latérale
- Corps en acier trempé et rectifié sur toutes les faces
- Répression basse incorporée
- Hauteur du socle H: $\leq 0,01$ mm

Lieferumfang:

- Bedienungsanleitung
- Incl. Spannschlüssel
- 4 Stück Spannpratzen
- 4 Stück T-Nutensteine 18mm
- Messprotokoll

Delivery:

- Instructions for use
- Wrench
- 4 pcs. vice clamps
- 4 pcs. T-nuts 18mm
- Test certificate

Livraison avec:

- Mode d'emploi
- Clé de serrage
- 4 Mors de serrage
- 4 Tasseaux pour rainures en T
- Protocole de mesure

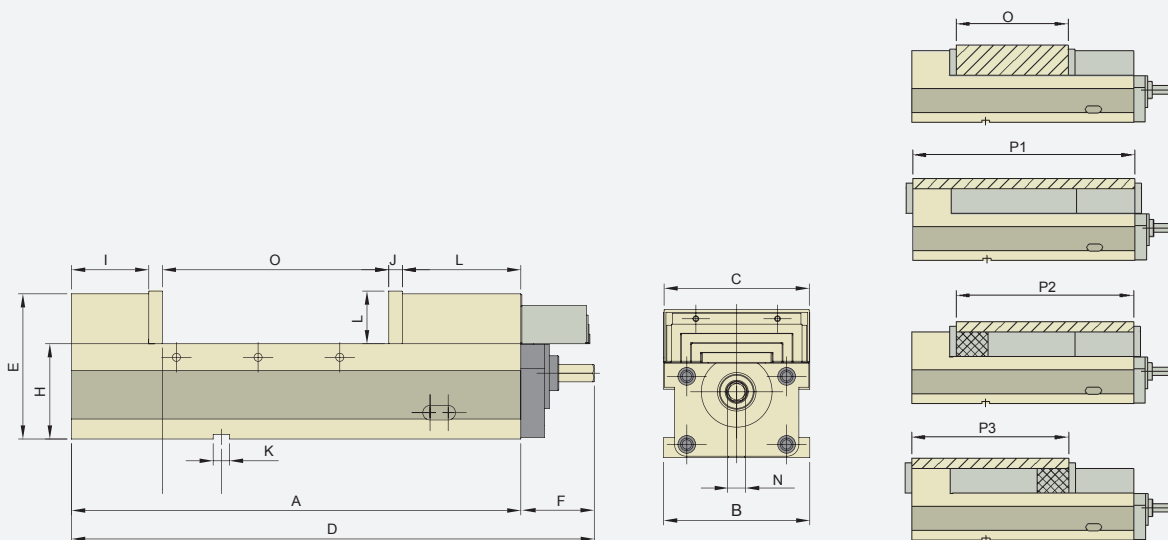

Bestell-Nr. Order no. Référence	Ausführung Version Type	A	B	C	D	E	F	G	H	I	J	K	L	M	N	O	P1	P2	P3	kg
KS16010	AVC-160G/HV	495	161	160	576	160	81	65	105	85	15	18	130	58	19	250	250-480	250-370	250-330	52
KS16020	AVC-200G/HV	580	201	200	670	170	90	85	110	90	18	18	130	63	19	250	290-550	290-430	290-370	75





Präzisionsschraubstöcke mechanisch

Precision vices mechanical

Étaux de précision mécanique

Ausführung:

- Horizontal, vertikal oder seitlich aufspannbar
- Stahlkörper allseitig geschliffen und gehärtet
- Eingebauter Niederzug
- Betthöhe H: $\leq 0,01$ mm

Construction:

- Clamping positions: horizontal, vertical and lateral
- The steel body is hardened and grinded all-round
- Integrated pull-down mechanism
- Bed height H: $\leq 0,01$ mm

Type:

- Positions de serrage: horizontale, verticale ou latérale
- Corps en acier trempé et rectifié sur toutes les faces
- Répression basse incorporée
- Hauteur du socle H: $\leq 0,01$ mm

Lieferumfang:

- Bedienungsanleitung
- Incl. Spannschlüssel
- 4 Stück Spannpratzen
- 4 Stück T-Nutensteine 18mm
- Messprotokoll

Delivery:

- Instructions for use
- Wrench
- 4 pcs. vice clamps
- 4 pcs. T-nuts 18mm
- Test certificate

Livraison avec:

- Mode d'emploi
- Clé de serrage
- 4 Mors de serrage
- 4 Tasseaux pour rainures en T
- Protocole de mesure

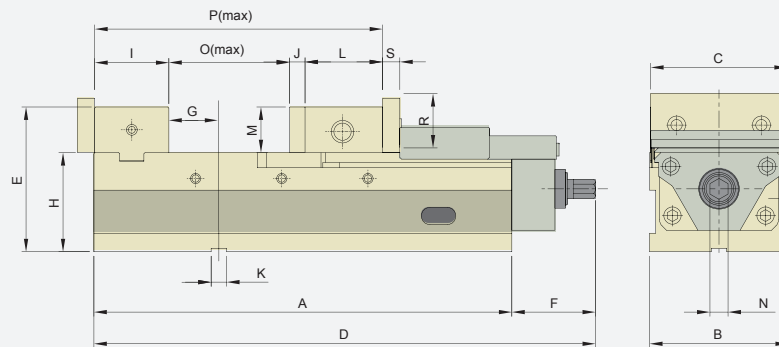
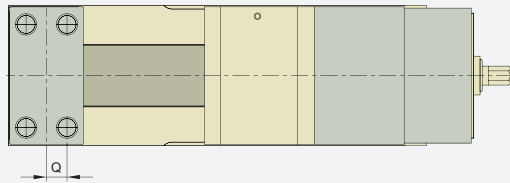
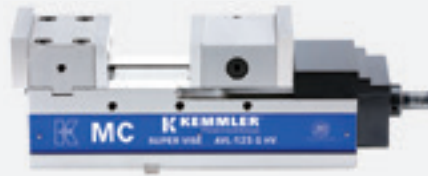

10

Bestell-Nr. Order no. Référence	Ausführung Version Type	A	B	C	D	E	F	G	H	I	J	K	L	M	N	O	P	Q	R	S	kg
KS05010	AVL-100G/HV	324	104	102,0	437	130	104	41	85	73	15	18	86,5	45	19	140	314,5	20,0	55	17	27
KS05020	AVL-125G/HV	390	127	125,0	480	153	105	66	100	78	15	18	87,5	53	19	201	381,5	22,5	63	20	43
KS05030	AVL-160G/HV	485	161	159,5	625	225	120	76	115	86	18	18	80,0	53	21	295	479,0	25,0	63	20	71
KS05040	AVL-200G/HV	535	202	199,5	660	260	128	93	120	101	18	18	95,0	58	19	320	534,0	31,0	73	20	98



10.34



10.27



10.30

Präzisionsschraubstöcke Pneumatik hydraulisch

Precision vices pneumatic hydraulic

Étaux de précision pneumatiques hydrauliques



Ausführung:

- Geeignet für Serienfertigung
- Horizontal und vertikal aufspannbar
- Stahlkörper allseitig geschliffen und gehärtet
- Eingebauter Niederzug
- Betthöhe H: ≤ 0,01 mm

Construction:

- Suitable for mass production
- Clamping positions: horizontal and vertical
- The steel body is hardened and grinded all-round
- Integrated pull-down mechanism
- Bed height H: ≤ 0,01 mm

Type:

- Approprié à la fabrication en série
- Positions de serrage: horizontale, ou verticale
- Corps en acier trempé et rectifié sur toutes les faces
- Répression basse incorporée
- Hauteur du socle H: ≤ 0,01 mm

Lieferumfang:

- Bedienungsanleitung
- Incl. Spannschlüssel
- 4 Stück Spannpratzen
- 4 Stück T-Nutensteine 18mm
- Messprotokoll

Delivery:

- Instructions for use
- Wrench
- 4 pcs. vice clamps
- 4 pcs. T-nuts 18mm
- Test certificate

Livraison avec:

- Mode d'emploi
- Clé de serrage
- 4 Mors de serrage
- 4 Tasseaux pour rainures en T
- Protocole de mesure

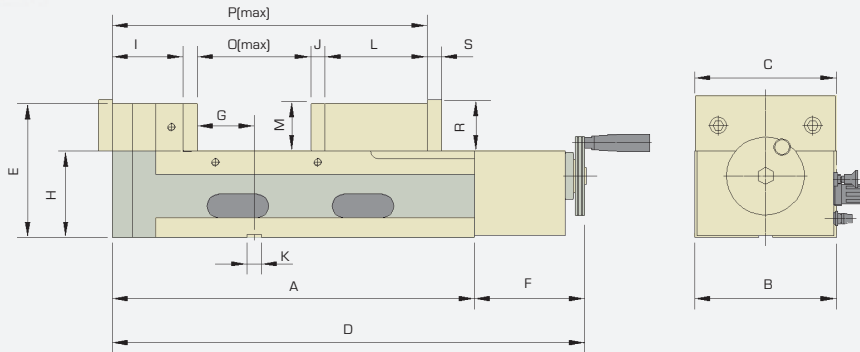
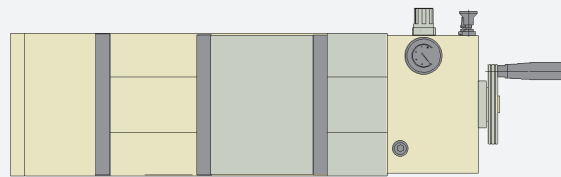
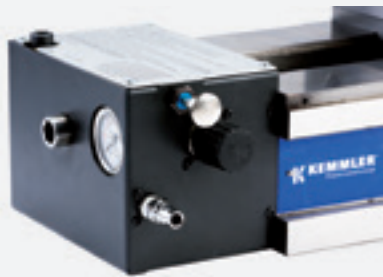

Bestell-Nr. Order no. Référence	Ausführung Version Type	A	B	C	D	E	F	G	H	I	J	K	L	M	N	O	P	R	S	kN	kg
KS18150	AMP-150G/HV	380	130	130	520	157	140	60	105	85	15	18	110	52	-	0-150	200-380	62	15	62	52
KS18160	AMP-160G/HV	400	160	160	540	157	140	60	105	87	15	18	120	52	-	0-160	210-400	62	15	62	58
KS18165	AMP-165G/HV	490	160	160	630	157	140	60	105	87	15	18	120	55	-	0-250	210-490	65	15	62	65
KS18180	AMP-180G/HV	460	180	180	600	170	140	90	110	90	18	18	130	60	-	0-200	220-460	70	18	90	75
KS18200	AMP-200G/HV	470	200	200	610	170	140	90	110	90	18	18	140	60	-	0-200	230-470	70	18	90	82
KS18300	AMP-300G/HV	570	200	200	710	170	140	90	110	90	18	18	140	60	-	0-300	230-570	70	18	90	93



10





Doppelspannstöcke mechanisch

Twin vices mechanical

Étaux à double serrage mécanique

Ausführung:

- Doppelspannung mit 2 beweglichen und einer festen Spannbacke
- Horizontal und vertikal aufspannbar
- Stahlkörper allseitig geschliffen und gehärtet
- Eingebauter Niederzug
- Spannwiederholgenauigkeit $\leq 0,01$ mm
- Mittenspanngenauigkeit $\leq 0,01$ mm
- Betthöhe H: $\leq 0,01$ mm

Construction:

- *Double-clamping via two mobile and one fixed jaw.*
- *Clamping positions: horizontal, and vertical*
- *The steel body is hardened and grinded all-round*
- *Integrated pull-down mechanism*
- *Repeating accuracy $\leq 0,01$ mm*
- *Clamping accuracy at the centre $\leq 0,01$ mm*
- *Bed height H: $\leq 0,01$ mm*

Type:

- Double serrage avec deux mâchoires mobile et une mâchoire fixe
- Positions de serrage: horizontale, ou verticale
- Corps en acier trempé et rectifié sur toutes les faces
- Répression basse incorporée
- Précision de la répétition $\leq 0,01$ mm
- Précision de la répétition au centre $\leq 0,01$ mm
- Hauteur du socle H: $\leq 0,01$ mm

Lieferumfang:

- Bedienungsanleitung
- Incl. Spannschlüssel
- 4 Stück Spannpratzen
- 4 Stück T-Nutensteine 18mm
- Messprotokoll

Delivery:

- *Instructions for use*
- *Wrench*
- 4 pcs. vice clamps
- 4 pcs. T-nuts 18mm
- *Test certificate*

Livraison avec:

- Mode d'emploi
- Clé de serrage
- 4 Mors de serrage
- 4 Tasseaux pour rainures en T
- Protocole de mesure

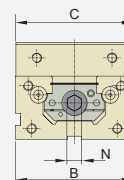
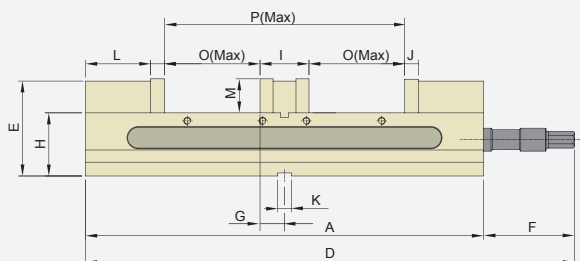
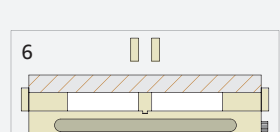
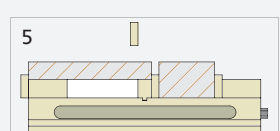
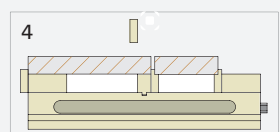
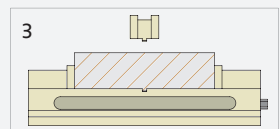
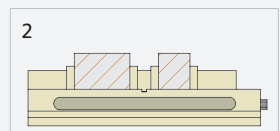
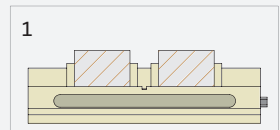
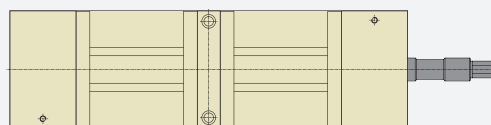
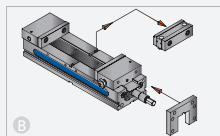
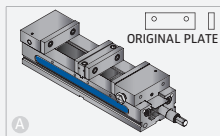

10

Bestell-Nr. Order no. Référence	Ausführung Version Type	A	B	C	D	E	F	G	H	I	J	K	L	M	N	O	P	kg
KS09010	TLD-40G/HV	405	104	103	459	96,5	54	27,5	63,50	55	15	18	69	38,0	14	90	235	20
KS09020	TLD-60G/HV	520	154	153	536	124,05	16	33,0	82,55	66	18	18	86,5	44,5	19	125	316	52

Doppelspannstöcke mechanisch

Twin vices mechanical

Étaux à double serrage mécanique



Ausführung:

- Doppelspannung mit 2 beweglichen und einer festen Spannbacke
- Horizontal und vertikal aufspannbar
- Stahlkörper allseitig geschliffen und gehärtet
- Eingebauter Niederzug
- Spannweitenholgenauigkeit $\leq 0,01$ mm
- Mittenspanngenauigkeit $\leq 0,01$ mm
- Betthöhe H: $\leq 0,01$ mm

Construction:

- Double-clamping via two mobile and one fixed jaw.
- Clamping positions: horizontal and vertical
- The steel body is hardened and grinded all-round
- Integrated pull-down mechanism
- Repeating accuracy $\leq 0,01$ mm
- Clamping accuracy at the centre $\leq 0,01$ mm
- Bed height H: $\leq 0,01$ mm

Type:

- Double serrage avec deux mâchoires mobile et une mâchoire fixe
- Positions de serrage: horizontale ou verticale
- Corps en acier trempé et rectifié sur toutes les faces
- Répression basse incorporée
- Précision de la répétition $\leq 0,01$ mm
- Précision de la répétition au centre $\leq 0,01$ mm
- Hauteur du socle H: $\leq 0,01$ mm

Lieferumfang:

- Bedienungsanleitung
- Incl. Spannschlüssel
- 4 Stück Spannpratzen
- 4 Stück T-Nutensteine 18mm
- Messprotokoll

Delivery:

- Instructions for use
- Wrench
- 4 pcs. vice clamps
- 4 pcs. T-nuts 18mm
- Test certificate

Livraison avec:

- Mode d'emploi
- Clé de serrage
- 4 Mors de serrage
- 4 Tasseaux pour rainures en T
- Protocole de mesure

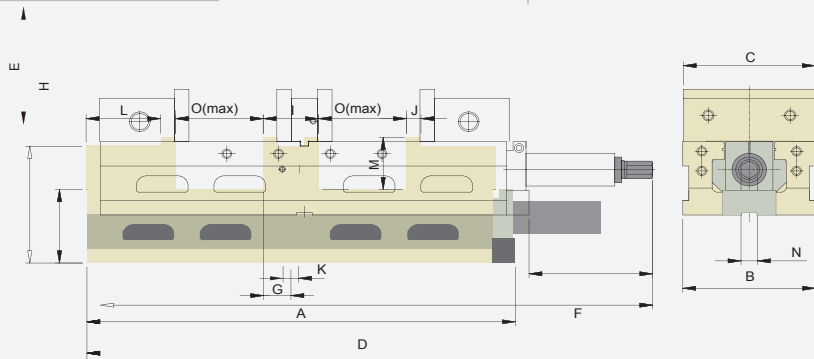
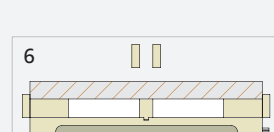
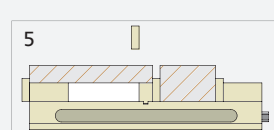
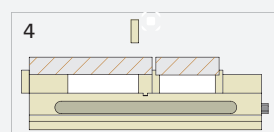
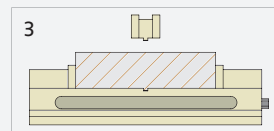
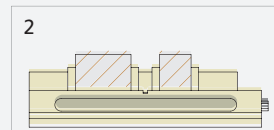
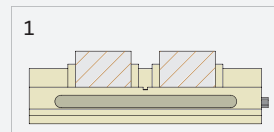
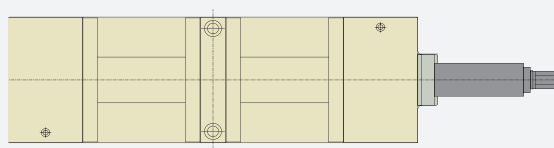
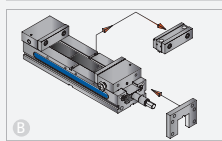
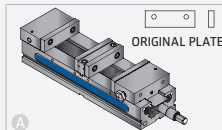

Bestell-Nr. Order no. Référence	Ausführung Version Type	A	B	C	D	E	F	G	H	I	J	K	L	M	N	O	kg
KS10010	ALD-60G/HV	497	154	152	610	143	113	32	90	64	17	18	86,5	58	14	34-102	63,5





5-Achs Maschinen-Schraubstöcke

5-Axis-Machine vices

Étaux à 5-axes

Ausführung:

- Horizontal, vertikal oder seitlich aufspannbar
- Stahlkörper allseitig geschliffen und gehärtet
- Eingebauter Niederzug
- Betthöhe H: $\leq 0,01$ mm

Construction:

- Clamping positions: horizontal, vertical and lateral
- The steel body is hardened and grinded all-round
- Integrated pull-down mechanism
- Bed height H: $\leq 0,01$ mm

Type:

- Positions de serrage: horizontale, verticale ou latérale
- Corps en acier trempé et rectifié sur toutes les faces
- Répression basse incorporée
- Hauteur du socle H: $\leq 0,01$ mm

Lieferumfang:

- Bedienungsanleitung
- Incl. Spannschlüssel
- 4 Stück Spannpratzen
- 4 Stück T-Nutensteine 18mm
- Messprotokoll

Delivery:

- Instructions for use
- Wrench
- 4 pcs. vice clamps
- 4 pcs. T-nuts 18mm
- Test certificate

Livraison avec:

- Mode d'emploi
- Clé de serrage
- 4 Mors de serrage
- 4 Tasseaux pour rainures en T
- Protocole de mesure

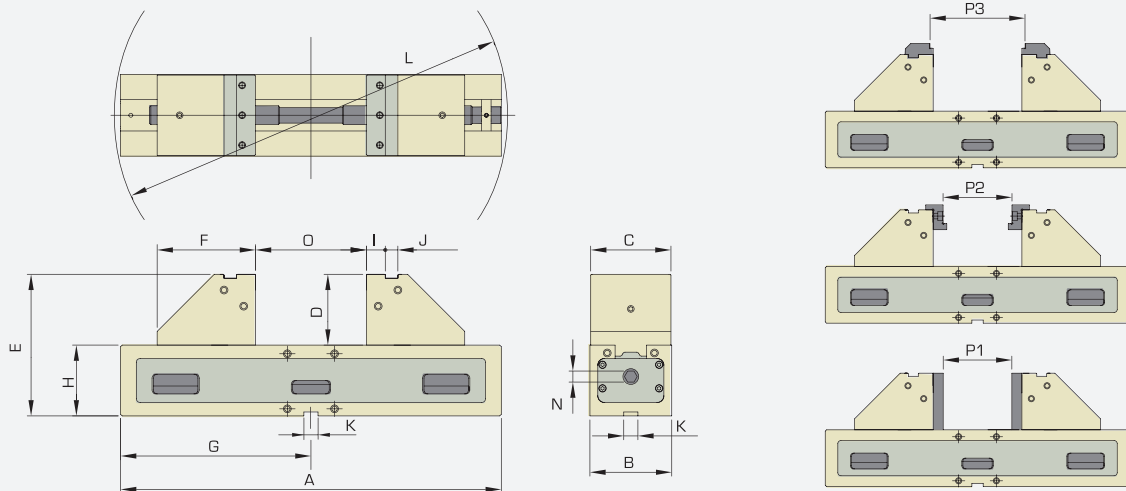

10



10.34



10.24

Bestell-Nr. Order no. Référence	Ausführung Version Type	A	B	C	D	E	F	G	H	I	J	K	L	N	O	P1	P2	P3	KN	kg
KS20100	ALT-100M	324	104	102	90	180	125	162	90	24	16	18	350	14	74	44	42	84	20	20
KS20101	ALT-100L	484	104	102	90	180	125	242	90	24	16	18	500	14	184	102	200	240	20	30

Mehrfachspannsystem 3-teilig

Multiple Clamping System 3-parts

Système multiple de serrage 3-pièces



Ausführung:

- Mit mechanischem Spannkraftverstärker
- Spannkraft voreinstellbar durch Rillenmarkierung
- Stahlkörper allseitig geschliffen und gehärtet
- Eingebauter Niederzug
- Betthöhe H: $\leq 0,01$ mm

Construction:

- With mechanical booster
- Clamping force preadjustable by graduation lines
- The steel body is hardened and grinded all-round
- Integrated pull-down mechanism
- Bed height H: $\leq 0,01$ mm

Type:

- Avec répéteur de la tension du ressort
- La tension du ressort ce fait par préréglage avec marquage.
- Corps en acier trempé et rectifié sur toutes les faces
- Répression basse incorporée
- Hauteur du socle H: $\leq 0,01$ mm

Lieferumfang:

- Bedienungsanleitung
- Incl. Spannschlüssel
- 4 Stück Spannpratzen
- 4 Stück T-Nutensteine 18mm
- Messprotokoll

Delivery:

- Instructions for use
- Wrench
- 4 pcs. vice clamps
- 4 pcs. T-nuts 18 mm
- Test certificate

Livraison avec:

- Mode d'emploi
- Clé de serrage
- 4 Mors de serrage
- 4 Tasseaux pour rainures en T
- Protocole de mesure

Spannkraft:

KS22020 = 50 kN

Clamping force:

KS22020 = 50 kN

Tension du ressort:

KS22020 = 50 kN

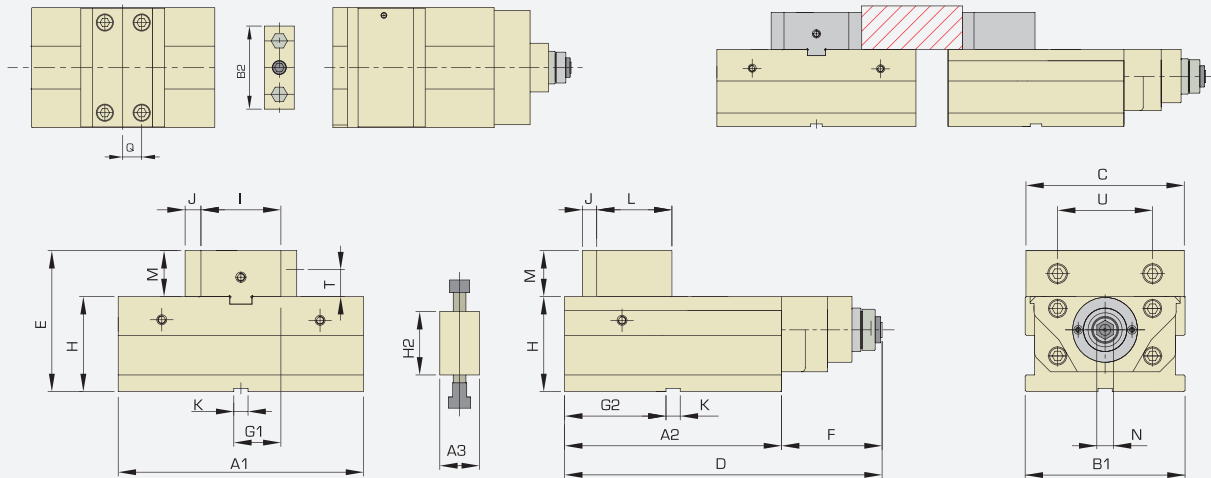
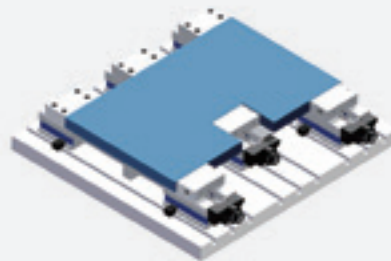
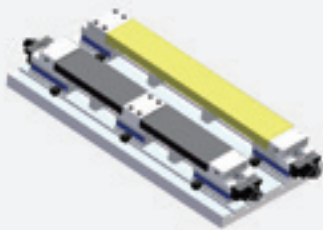

Bestell-Nr. Order no. Référence	Ausführung Version Type	A1	A2	A3	B1	B2	C	D	E	F	G1	G2	H	I	J	K	L	M	N	Q
KS22020	AOM-200/HV	210	270	50	202	140	199,5	398	178	128	59,5	126	120	101	18	18	95	58	19	31

Bestell-Nr. Order no. Référence	Ausführung Version Type	T	U	KN	kg
KS22020	AOM-200/HV	29	120	50	95





Präzisionschraubstöcke mechanisch

Precision vices mechanical

Étaux de précision mécanique

Ausführung:

- Horizontal, vertikal oder seitlich aufspannbar
- Stahlkörper allseitig geschliffen und gehärtet
- Eingebauter Niederzug
- Betthöhe H: $\leq 0,01$ mm

Construction:

- Clamping positions: horizontal, vertical and lateral
- The steel body is hardened and grinded all-round
- Integrated pull-down mechanism
- Bed height H: $\leq 0,01$ mm

Type:

- Positions de serrage: horizontale, verticale ou latérale
- Corps en acier trempé et rectifié sur toutes les faces
- Répression basse incorporée
- Hauteur du socle H: $\leq 0,01$ mm

Lieferumfang:

- Bedienungsanleitung
- Incl. Spannschlüssel
- 4 Stück Spannpratzen
- 4 Stück T-Nutensteine 18mm
- Messprotokoll

Delivery:

- Instructions for use
- Wrench
- 4 pcs. vice clamps
- 4 pcs. T-nuts 18mm
- Test certificate

Livraison avec:

- Mode d'emploi
- Clé de serrage
- 4 Mors de serrage
- 4 Tasseaux pour rainures en T
- Protocole de mesure

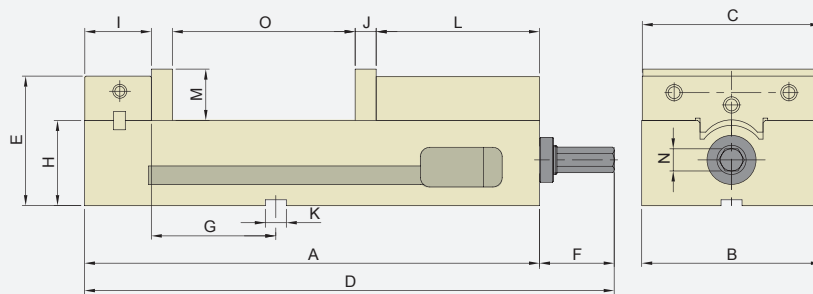

10

Bestell-Nr. Order no. Référence	Ausführung Version Type	A	B	C	D	E	F	G	H	I	J	K	L	M	N	O	kg
KS12010	AMC-40G/HV	330	105	102	372	100	42	82,6	68	46,8	21	18	106	40,0	14	125	21,0
KS12020	AMC-60G/HV	390	154	153	455	111	65	123	73	57,0	18	18	140	44,5	19	148	36,5



10.34



10.27



10.30

Präzisionsschraubstöcke mechanisch

Precision vices mechanical

Étaux de précision mécanique



Ausführung:

- Horizontal und vertikal aufspannbar
- Stahlkörper geschliffen und gehärtet
- Eingebauter Niederzug
- Betthöhe H: $\leq 0,01$ mm

Construction:

- Clamping positions: horizontal and vertical
- The steel body is hardened and grinded
- Integrated pull-down mechanism
- Bed height H: $\leq 0,01$ mm

Type:

- Positions de serrage: horizontale ou verticale
- Corps en acier trempé et rectifié sur toutes
- Répression basse incorporée
- Hauteur du socle H: $\leq 0,01$ mm

Lieferumfang:

- Bedienungsanleitung
- Incl. Spannschlüssel
- Messprotokoll

Delivery:

- Instructions for use
- Wrench
- Test certificate

Livraison avec:

- Mode d'emploi
- Clé de serrage
- Protocole de mesure



ATD



ATW

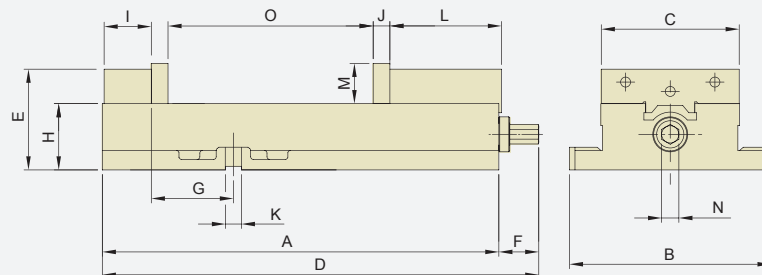

Bestell-Nr. Order no. Référence	Ausführung Version Type	A	B	C	D	E	F	G	H	I	J	K	L	M	N	O	kg
KS11010	ATD-460	312,5	166	103,5	352,5	85,65	40	71	57,15	35,1	15	12	102	35,0	14,0	103,9	18
KS11020	ATD-570	368,0	194	127,0	404,0	97,00	36	85	63,5	40,5	17	16	120	38,1	16,0	127,0	25
KS11030	ATW-675	432,0	235	152,0	476,0	111,02	44	108	73,02	52,0	18	17,48 / 18	123	44,5	19,0	192,0	36
KS11040	ATW-689	437	222	152	481,0	111,025	44	90,5	73,025	52	18	17,48 / 18	123	44,5	19,0	226,0	36
KS11050	ATW-810	555	295	203	585,0	134,074	30	125,7	84,074	58	24,2	20,65 / 18	157	56,0	19,0	265,0	68

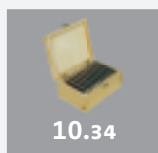

10





Präzisionsschraubstöcke mechanisch

Precision vices mechanical

Étaux de précision mécanique

Ausführung:

- Horizontal, vertikal oder seitlich aufspannbar
- Stahlkörper allseitig geschliffen und gehärtet
- Eingebauter Niederzug
- Betthöhe H: $\leq 0,01$ mm

Lieferumfang:

- Bedienungsanleitung
- Incl. Spannschlüssel
- 4 Stück Spannpratzen
- 4 Stück T-Nutensteine 18mm
- Messprotokoll

Construction:

- Clamping positions: horizontal, vertical and lateral
- The steel body is hardened and grinded all-round
- Integrated pull-down mechanism
- Bed height H: $\leq 0,01$ mm

Delivery:

- Instructions for use
- Wrench
- 4 pcs. vice clamps
- 4 pcs. T-nuts 18mm
- Test certificate

Type:

- Positions de serrage: horizontale, verticale ou latérale
- Corps en acier trempé et rectifié sur toutes les faces
- Répression basse incorporée
- Hauteur du socle H: $\leq 0,01$ mm

Livraison avec:

- Mode d'emploi
- Clé de serrage
- 4 Mors de serrage
- 4 Tasseaux pour rainures en T
- Protocole de mesure

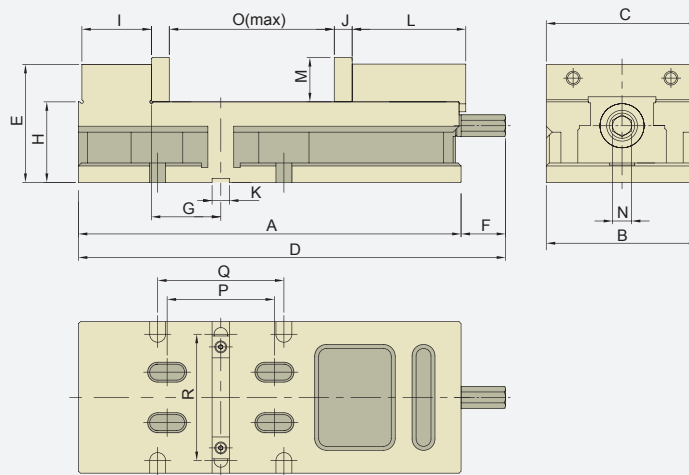
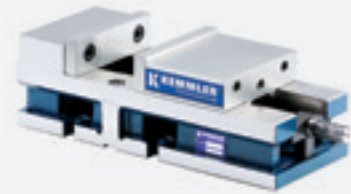
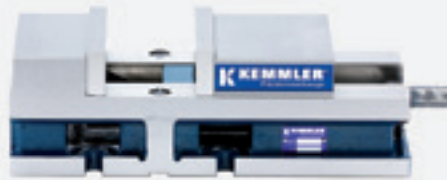

10

Bestell-Nr. Order no. Référence	Ausführung Version Type	A	B	C	D	E	F	G	H	I	J	K	L	M	N	O	P	Q	R	kg
KS13010	MG-60G/HV	385	152,45	152	431,8	118,7	46,8	61,1	81	69,9	18	18	114,3	44,5	19	163	107,95	127	127	31



10.34



10.27



10.30



10.33

Präzisionsschraubstöcke hydraulisch

Precision vices hydraulic

Étaux de précision hydraulique



Ausführung:

- Spannkraft voreinstellbar durch Rillenmarkierung
- Horizontal und vertikal aufspannbar
- 50° schwenkbar
- Führungen geschliffen und gehärtet

Lieferumfang:

- Bedienungsanleitung
- Incl. Spannschlüssel
- Messprotokoll

Spannkraft:

KS08010 = 25 kN
KS08020 = 44 kN

Construction:

- Clamping force preadjustable by graduation lines
- Clamping positions: horizontal and vertical
- 50° pivotable
- Slides hardened and grinded

Delivery:

- Instructions for use
- Wrench
- Test certificate

Clamping force:

KS08010 = 25 kN
KS08020 = 44 kN

Type:

- La tension du ressort ce fait par préréglage avec marquage.
- Positions de serrage: horizontale ou verticale
- Pivotant de 50°
- Rainures trempées et rectifiées

Livraison avec:

- Mode d'emploi
- Clé de serrage
- Protocole de mesure

Tension du ressort:

KS08010 = 25 kN
KS08020 = 44 kN

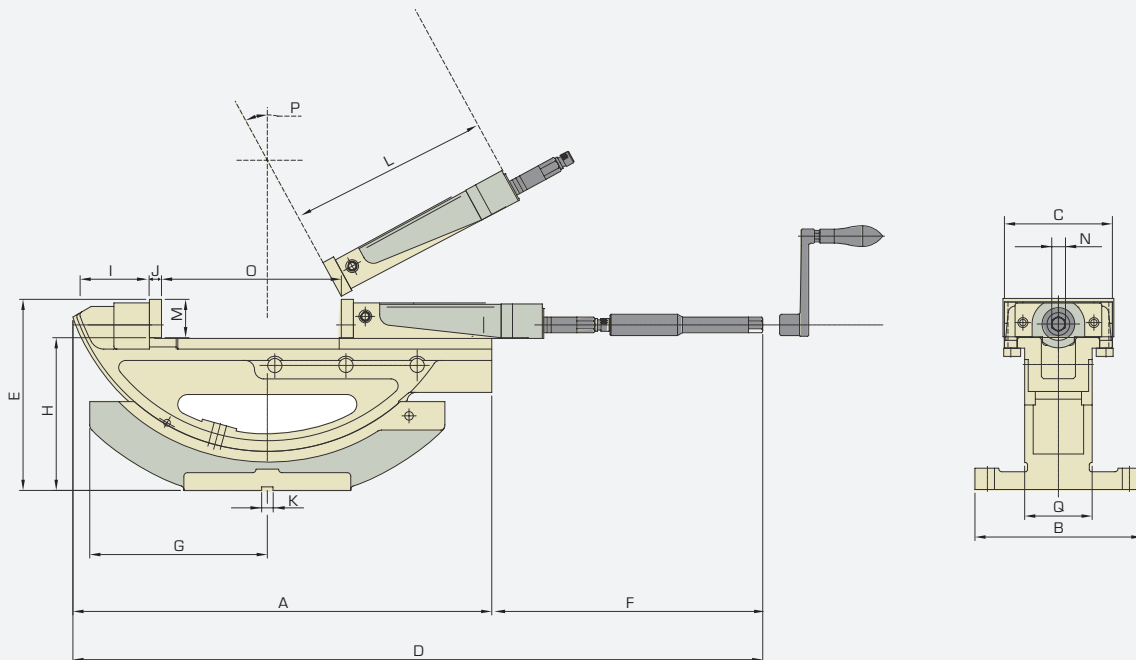

Bestell-Nr. Order no. Référence	Ausführung Version Type	Winkel E Angle E Angle E																		kN	kg
		A	B	C	D	F	G	H	I	J	K	L	M	N	O	P	Q				
KS08010	HPT-40	330	160	104	525	177	195	172	141	65	11	16	153	36	14	170	50	65,0	25	28	
KS08020	HPT-60	590	235	152	812	264	222	250	210	97	15	16	175	54	19	300	50	94,5	44	75	

Präzisionsschraubstöcke mechanisch mit Spannkraftverstärker

Precision vices mechanical with mechanical booster

Étaux de précision mécanique avec répéteur de la tension du ressort

Ausführung:

- Mit mechanischem Spannkraftverstärker
- Spannkraft voreinstellbar durch Rillenmarkierung
- Horizontal und vertikal aufspannbar
- Führungen geschliffen und gehärtet
- Betthöhe H: $\leq 0,01$ mm

Lieferumfang:

- Bedienungsanleitung
- Incl. Spannschlüssel
- Messprotokoll

Spannkraft:

KS06010 = 40 kN
KS06020 = 50 kN
KS06030 = 60 kN

Construction:

- With mechanical booster
- Clamping force preadjustable by graduation lines
- Clamping positions: horizontal and vertical
- Slides hardened and grinded
- Bed height H: $\leq 0,01$ mm

Delivery:

- Instructions for use
- Wrench
- Test certificate

Clamping force:

KS06010 = 40 kN
KS06020 = 50 kN
KS06030 = 60 kN

Type:

- Avec répéteur de la tension du ressort
- La tension du ressort ce fait par pré réglage avec marquage.
- Positions de serrage: horizontale ou verticale
- Rainures trempées et rectifiées
- Hauteur du socle H: $\leq 0,01$ mm

Livraison avec:

- Mode d'emploi
- Clé de serrage
- Protocole de mesure

Tension du ressort:

KS06010 = 40 kN
KS06020 = 50 kN
KS06030 = 60 kN

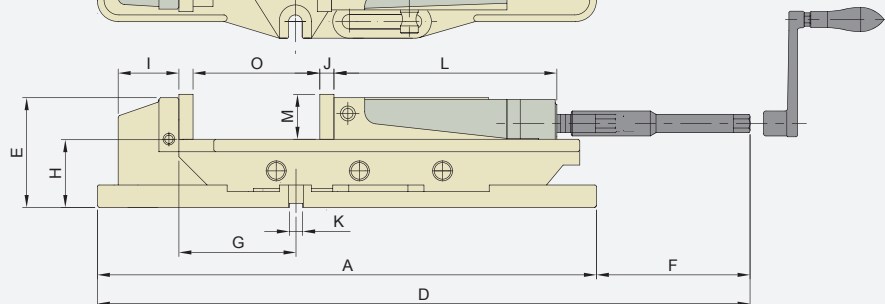
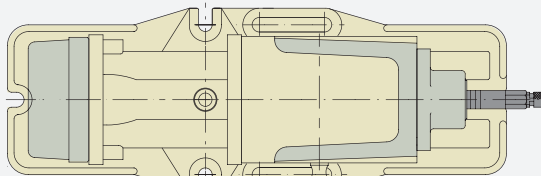
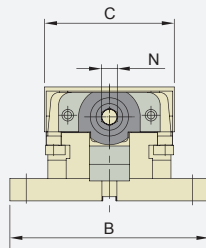
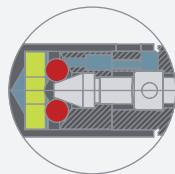

10

Mit patentiertem mechanischem Spannkraftverstärker:

- 1 kein Ölverlust
- 2 genaue Wiederholbarkeit der Spannkraft
- 3 keine Veränderung der Spannkraft
- 4 keine Vibrationen während der Bearbeitung
- 5 lange Lebensdauer

With patented mechanical booster:

- 1 no loss of oil
- 2 exact repeatability of the clamping force
- 3 constant clamping force
- 4 no vibrations during the operation
- 5 long life

Avec répéteur de la tension du ressort patenté:

- 1 pas de déchet d'huile hydraulique
- 2 répétabilité exacte de la tension du ressort
- 3 tension du ressort constante
- 4 pas de vibrations durant l'usage
- 5 durabilité longue

Bestell-Nr. Order no. Référence	Ausführung Version Type	A	B	C	D	E	F	G	H	I	J	K	L	M	N	O	kN	kg
KS06010	MP-50A	538	185	130	670	117	132	82	72	76	15	16	175	46	19	220	40	38
KS06020	MP-60A	620	240	154	800	132	180	140	82	82	17	16	208	54	19	300	50	58
KS06030	MP-80A	700	280	206	900	160	200	118	100	100	21	18	245	62	19	300	60	104

Präzisionsschraubstöcke hydraulisch

Precision vices hydraulic

Étaux de précision hydraulique



Ausführung:

- Spannkraft voreinstellbar durch Rillenmarkierung
- Horizontal und vertikal aufspannbar
- Führungen geschliffen und gehärtet
- Eingebauter Niederzug
- Betthöhe H: $\leq 0,01$ mm

Lieferumfang:

- Bedienungsanleitung
- Incl. Spannschlüssel
- Messprotokoll

Spannkraft:

KS07010 = 25 kN
 KS07020 = 35 kN
 KS07030 = 44 kN
 KS07040 = 66 kN

Construction:

- Clamping force preadjustable by graduation lines
- Clamping positions: horizontal and vertical
- Slides hardened and grinded
- Integrated pull-down mechanism
- Bed height H: $\leq 0,01$ mm

Delivery:

- Instructions for use
- Wrench
- Test certificate

Clamping force:

KS07010 = 25 kN
 KS07020 = 35 kN
 KS07030 = 44 kN
 KS07040 = 66 kN

Type:

- La tension du ressort ce fait par préréglage avec marquage.
- Positions de serrage: horizontale, ou verticale
- Rainures trempées et rectifiées
- Répression basse incorporée
- Hauteur du socle H: $\leq 0,01$ mm

Livraison avec:

- Mode d'emploi
- Clé de serrage
- Protocole de mesure

Tension du ressort:

KS07010 = 25 kN
 KS07020 = 35 kN
 KS07030 = 44 kN
 KS07040 = 66 kN

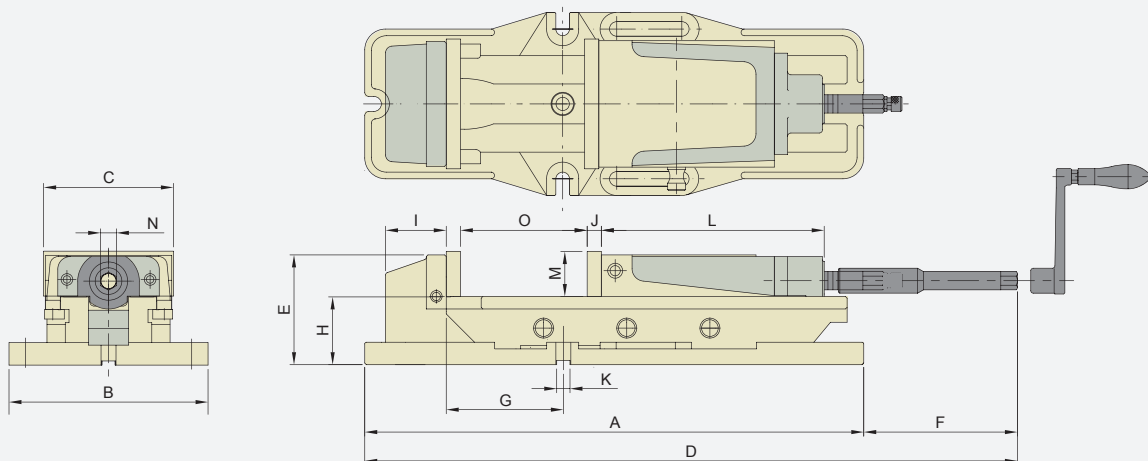

Bestell-Nr. Order no. Référence	Ausführung Version Type	A	B	C	D	E	F	G	H	I	J	K	L	M	N	O	kN	kg
KS07010	HP-40A	435	160	104	525	93	90	53	58	76	11	16	153	36	14	170	25	24
KS07020	HP-50A	538	185	130	670	117	132	82	72	82	15	16	175	46	19	220	35	37
KS07030	HP-60A	620	240	154	800	132	180	140	82	81	17	16	208	54	19	300	44	58
KS07040	HP-80A	700	280	206	900	160	200	118	100	101	21	18	245	62	19	300	66	104



Präzisionsschraubstöcke mechanisch

Precision vices mechanical

Étaux de précision mécanique

Ausführung:

- Horizontal, vertikal oder seitlich aufspannbar
- Stahlkörper allseitig geschliffen und gehärtet
- Betthöhe H: $\leq 0,01$ mm

Construction:

- Clamping positions: horizontal, vertical and lateral
- The steel body is hardened and grinded all-round
- Bed height H: $\leq 0,01$ mm

Type:

- Positions de serrage: horizontale, verticale ou latérale
- Corps en acier trempé et rectifié sur toutes les faces
- Hauteur du socle H: $\leq 0,01$ mm

Lieferumfang:

- Bedienungsanleitung
- Incl. Spannschlüssel
- 4 Stück Spannpratzen
- 4 Stück T-Nutensteine

Delivery:

- Instructions for use
- Wrench
- 4 pcs. vice clamps
- 4 pcs. T-nuts

Livraison avec:

- Mode d'emploi
- Clé de serrage
- 4 Mors de serrage
- 4 Tasseaux pour rainures en T

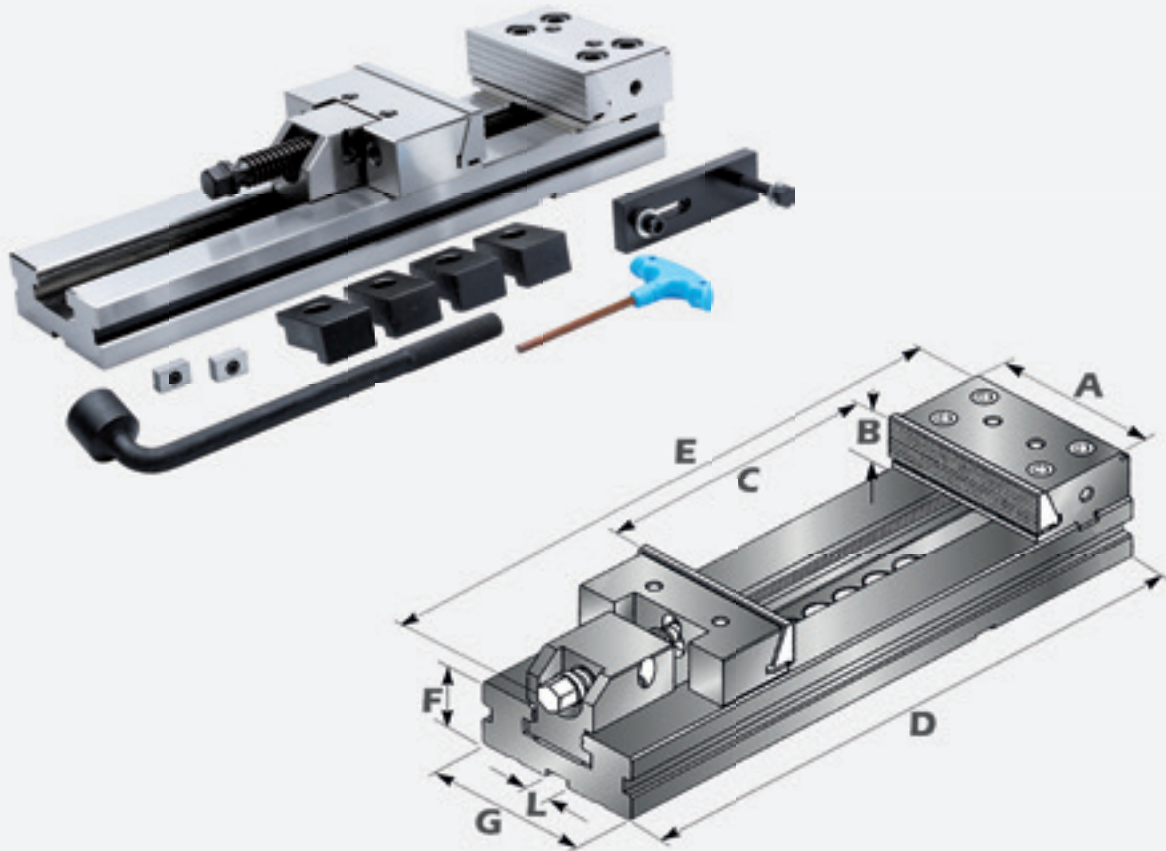

10

Bestell-Nr. Order no. Référence	Ausführung Version Type	A	B	C	D	E	F	G	L	kg
KS30125	ATI-125	125	40	150	345	410	40	95	16	13
KS30150	ATI-150	150	50	300	520	600	50	125	16	29
KS30175	ATI-175	175	60	300	555	630	58	145	16	42
KS30200	ATI-200	200	65	400	695	780	70	170	16	74

Drehplatte ATI
Swivel base ATI
Plateau tournant ATI

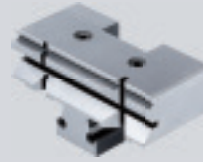
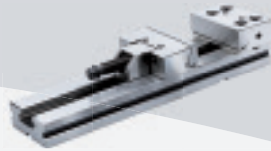

Prismenbacken
Prismatic jaws
Mors prismatiques

Bestell-Nr. Order no. / Référence	Ausführung Version / Type
Z.KS.30125	ATI-125
Z.KS.30150	ATI-150
Z.KS.30175	ATI-175
Z.KS.30200	ATI-200

Bestell-Nr. Order no. / Référence	Ausführung Version / Type
Z.KS.PR.30125	ATI-125
Z.KS.PR.30150	ATI-150
Z.KS.PR.30175	ATI-175
Z.KS.PR.30200	ATI-200



Niederzugbacken
Hold down jaws
Mors d'emboutissage

Bestell-Nr. Order no. / Référence	Ausführung Version / Type
Z.KS.NZ.30125	ATI-125
Z.KS.NZ.30150	ATI-150
Z.KS.NZ.30175	ATI-175
Z.KS.NZ.30200	ATI-200



Ersatzbacken ALT
Jaws ALT
Mors d'échange ALT

Bestell-Nr. Order no. / Référence	Ausführung Version / Type
Z.KS.ALT4401	ALT-100M/ALT-100L



Ersatzbacken ALT
Jaws ALT
Mors d'échange ALT

Bestell-Nr. Order no. / Référence	Ausführung Version / Type
Z.KS.ALT4402	ALT-100M/ALT-100L

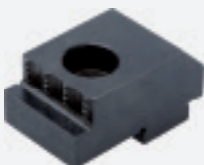

Ersatzbacken ALT
Jaws ALT
Mors d'échange ALT

Bestell-Nr. Order no. / Référence	Ausführung Version / Type
Z.KS.ALT4403	ALT-100M/ALT-100L



Ersatzbacken ALT
Jaws ALT
Mors d'échange ALT

Bestell-Nr. Order no. / Référence	Ausführung Version / Type
Z.KS.ALT4404	ALT-100M/ALT-100L





Schleif- und Kontrollschraubstöcke mit Gewindespindel

Grinding and inspection vices with threaded spindle

Etaux de contrôle et de rectification à réglage à vis

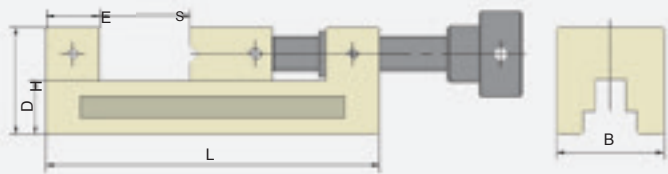
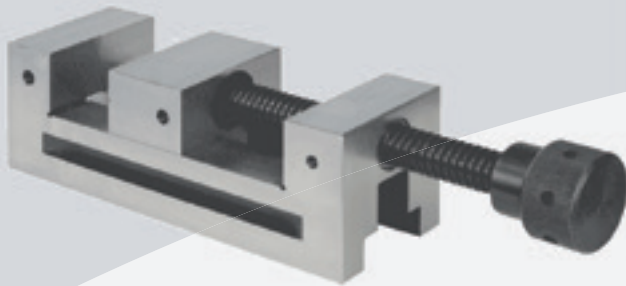

Bestell-Nr. Order no. Référence	B	H	E	D	S _{max}	L	kg
90.11.050	50	50	25	25	65	155	3
90.11.073	73	74	32	39	100	210	5
90.11.100	100	95	38	50	125	260	13

Schleif- und Kontrollschraubstöcke mit Schnellverstellung

Grinding and inspection vices with quick adjustment

Etaux de contrôle et de rectification à réglage rapide

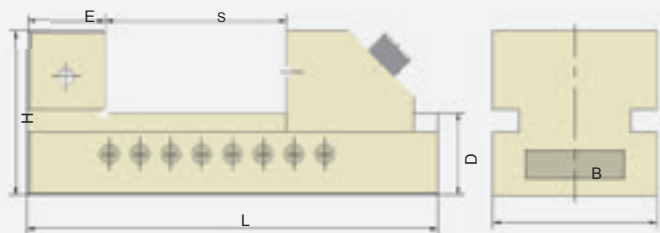
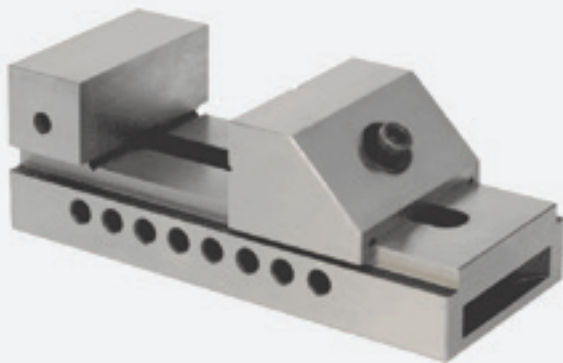

Bestell-Nr. Order no. Référence	B	H	E	D	S _{max}	L	kg
90.12.050	50	50	30	25	65	140	2
90.12.073	73	67	35	32	100	190	5
90.12.100	100	90	47	45	125	245	11

10



Universal-Schleif- und Kontrollschraubstöcke

Universal, grinding and inspection vices

Etaux de contrôle et de rectification universel

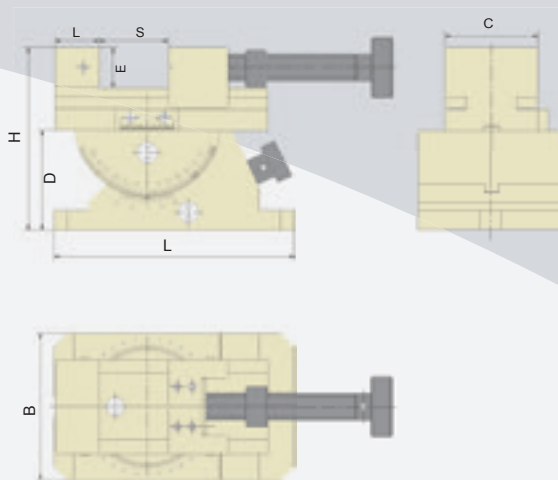
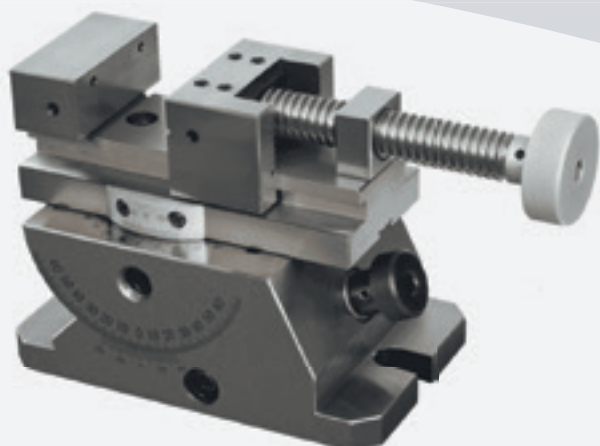

Bestell-Nr.
Order no.
Référence

	B	H	D	E	C	S _{max}	L	kg
90.17.080	110	137	75	30	70	80	180	12

Bohrmaschinenschraubstöcke, mechanisch

Vices for drilling machines, mechanical

Étaux pour foreuses, mécanique



Bestell-Nr.
Order no.
Référence

	Ausführung Version Type	kg
KS4080	MWM-80	2,3
KS4100	MWM-100	2,9
KS4150	MWM-150	5,7
KS4200	MWM-200	11,5

10





Ersatzbacken-Paare

Pair of spare jaws

Paire de mors de rechange

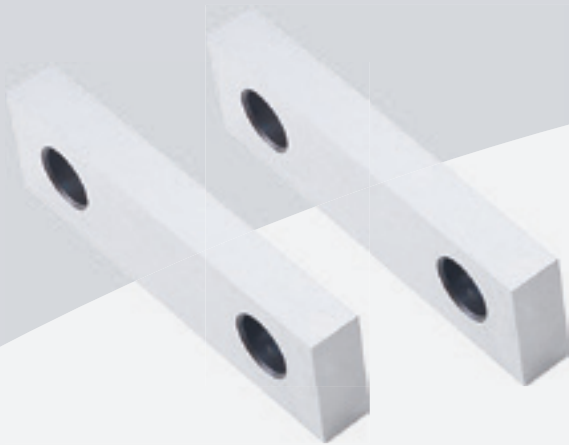

Bestell-Nr. Order no. Référence	Ausführung Version Type	Abmessung Size Dimension
Z.KS.SA.AT409	ATW-40	102 x 35 x 15
Z.KS.SA.AT509	ATW-50 / AMC-50	126 x 38,1 x 17
Z.KS.SA.ATL609	ATW-675 / ATW-689 / MG-60 / AMC-60 / TLD-60	151 x 44,5 x 18
Z.KS.SA.ATL809	ATW-810	206 x 56 x 24,2
Z.KS.SA.AMC409	AMC-40	102 x 40 x 21
Z.KS.SA.AVQ4401	AVQ-100 / AVL-100	102 x 45 x 15
Z.KS.SA.AVQ5401	AVQ-125 / AVL-125	124,7 x 53 x 15
Z.KS.SA.AVQ6401	AVQ-160 / AVL-160 / ALQ-160	159,2 x 53 x 18
Z.KS.SA.AVQ8401	AVQ-160 / AVL-200 / ALQ-160	199,5 x 58 x 18
Z.KS.SA.HP403	HP-40	104 x 36 x 11
Z.KS.SA.HP503	HP-50 / MP-50	130 x 46 x 15
Z.KS.SA.HP603	HP-60 / MP-60	154 x 54 x 17
Z.KS.SA.HP803	HP-80 / MP-80	206 x 62 x 21
Z.KS.SA.AVC6401	AVC-160 / AVM-160	160 x 58 x 15
Z.KS.SA.AVC8401	AVC-200 / AVM-200	200 x 63 x 18
Z.KS.SA.TLD4401	TLD-40	102 x 38 x 15
Z.KS.ST.ALD6403	ALD-60	152 x 58 x 17

10



Prismenbacken

Prismatic jaws

Mors prismatiques



Bestell-Nr. Order no. Référence	Ausführung Version Type	Abmessung Size Dimension	Größe Vee Type
Z.KS.PR.AT409R	ATW-40	102 x 35 x 31	40 x 120°
Z.KS.PR.AT509R	ATW-50	126 x 38,1 x 31	40 x 120°
Z.KS.PR.AT609R	ATW-675 / 689 / MG-60 / AMC-60 / TLD-60	151 x 44,5 x 31	45 x 120°
Z.KS.PR.AT809R	ATW-810	206 x 60 x 36	60 x 120°
Z.KS.PR.AVQ4407	AVQ / AVL-100	102 x 45 x 28	36,26 x 120°
Z.KS.PR.AVQ5407	AVQ / AVL-125	124,7 x 53 x 31	50 x 120°
Z.KS.PR.AVQ6407	AVQ / AVL-160	159,2 x 53 x 31	55 x 120°
Z.KS.PR.AVQ8407	AVQ / AVL-200	200 x 56 x 31	55 x 120°
Z.KS.PR.HP403R	HP-40	104 x 36 x 31	40 x 120°
Z.KS.PR.HP503R	HP / MP-50	130 x 46 x 31	45 x 120°
Z.KS.PR.HP603R	HP / MP-60	154 x 54 x 31	55 x 120°
Z.KS.PR.HP803R	HP / MP-80	206 x 62 x 36	60 x 120°
Z.KS.PR.AVC6407	AVC / AVM-160	160 x 58 x 30	55 x 120°
Z.KS.PR.AVC8407	AVC / AVM-200	200 x 63 x 36	70 x 120°
Z.KS.PR.TLD4404	TLD-40	102 x 38 x 31	40 x 120°
Z.KS.PR.ALD6404	ALD-60	152 x 58 x 49	55 x 120°

Stufenbacken (Paar)

Step jaws (Pair)

Mors étagés (Paire)



Bestell-Nr. Order no. Référence	Ausführung Version Type	Abmessung Size Dimension	Stufe Step Cran
Z.KS.ST.AT409L	ATW-40	102 x 35 x 15	4 x 3,5
Z.KS.ST.AT509L	ATW-50	126 x 38,1 x 17	4 x 3,5
Z.KS.ST.AT609L	ATW-675 / 689 / MG-60 / AMC-60 / TLD-60	151 x 44,5 x 18	5 x 4,5
Z.KS.ST.AT809L	ATW-810	206 x 56 x 24,2	6 x 5,5
Z.KS.ST.AVQ4404	AVQ / AVL-100	102 x 45 x 15	5 x 5
Z.KS.ST.AVQ5404	AVQ / AVL-125	124,7 x 53 x 15	5 x 5
Z.KS.ST.AVQ6404	AVQ / AVL-160	159,2 x 53 x 18	5 x 4,5
Z.KS.ST.AVQ8404	AVQ / AVL-200	200 x 56 x 18	4 x 5
Z.KS.ST.AVC6404	AVC / AVM-160	160 x 58 x 15	5 x 5
Z.KS.ST.AVC8404	AVC / AVM-200	200 x 63 x 18	5 x 5
Z.KS.ST.AMC409L	AMC-40	102 x 40 x 21	4 x 3,5
Z.KS.ST.TLD4402	TLD-40	102 x 38 x 15	8 x 5
Z.KS.ST.ALD6403	ALD-60	152 x 58 x 17	8 x 5

10





Geriffelte Backen / Rillenbacken (Paar)

Serrated jaws (Pair)

Mors à rainures (Paire)

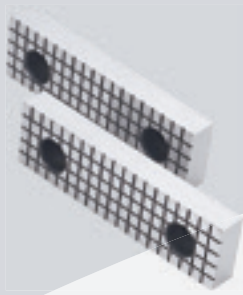

Bestell-Nr. Order no. Référence	Ausführung Version Type	Abmessung Size Dimension	Raster Grid Type
Z.KS.GR.AT409T	ATW-40	102 x 35 x 15	9 x 9
Z.KS.GR.AT509T	ATW-50	126 x 38,1 x 17	9 x 9
Z.KS.GR.AT609T	ATW-675 / 689 / MG-60 /AMC-60 / TLD-60	151 x 44,5 x 18	8 x 8
Z.KS.GR.AT809T	ATW-810	206 x 60 x 24,2	8 x 8
Z.KS.GR.AVQ4405	AVQ / AVL-100	102 x 45 x 15	9 x 9
Z.KS.GR.AVQ5405	AVQ / AVL-125	124,7 x 53 x 15	9 x 9
Z.KS.GR.AVQ6405	AVQ / AVL-160	159,2 x 53 x 18	9 x 9
Z.KS.GR.AVQ8405	AVQ / AVL-200	200 x 56 x 18	9 x 9
Z.KS.GR.HP403T	HP / MP-40	104 x 36 x 11	8 x 8
Z.KS.GR.HP503T	HP / MP-50	130 x 46 x 15	8 x 8
Z.KS.GR.HP603T	HP / MP-60	154 x 54 x 17	8 x 8
Z.KS.GR.HP803T	HP / MP-80	206 x 100 x 30	8 x 8
Z.KS.GR.AVC6405	AVC / AVM-160	160 x 58 x 15	8 x 8
Z.KS.GR.AVC8405	AVC / AVM-200	200 x 63 x 18	8 x 8
Z.KS.GR.TLD4403	TLD-40	102 x 38 x 15	9 x 9
Z.KS.GR.AMC409T	AMC-40	102 x 40 x 21	9 x 9

Niederzugbacken (Paar)

Hold down jaws (Pair)

Mors d'emboutissage (Paire)

10



Bestell-Nr. Order no. Référence	Ausführung Version Type	Größe-A Size-A Type-A	Größe-B Size-B Type-A
Z.KS.NZ.HP403DA	HP-40	104 x 36 x 12	104 x 36 x 18
Z.KS.NZ.HP503DA	HP / MP-50	130 x 46 x 15,12	130 x 46 x 21
Z.KS.NZ.HP603DA	HP / MP-60	154 x 54 x 17,99	154 x 54 x 21,5
Z.KS.NZ.HP803DA	HP / MP-80	206 x 62 x 21	206 x 62 x 25

Werkstückanschlag ATW

Workpiece stop ATW

Dispositif de butée ATW



Bestell-Nr. Order no. / Référence	Ausführung Version / Type
Z.KS.ATW40ST	4" ATW/40/ATD-460
Z.KS.ATW50ST	5" ATW-50/ATD-570
Z.KS.ATW60ST	6" ATW-675/ATW-689
Z.KS.ATW80ST	8" ATW-810

Werkstückanschlag, universal

Workpiece stop, universal

Dispositif de butée, universel



Bestell-Nr. Order no. / Référence	Ausführung Version / Type
Z.KS.ATS160BH	ATS-160BH/T-16mm

Winkelprisma, einstellbar

Adjustable prism square

Équerre à prisme, ajustable



Bestell-Nr. Order no. / Référence	Ausführung Version / Type
GAP-25	75x25x36x25
GAP-30	102x30x49x30
GAP-46	102x46x49x30

10





T-Nuten (T-Nutensteine)

T-Nuts

Tasseaux

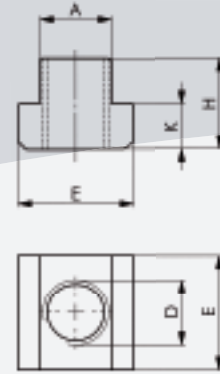
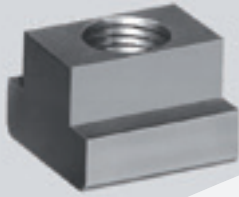

Bestell-Nr. Order no. Référence	Ausführung Version Type	A	E	H	K
Z.KS.80010	M6x8	7,7	13	10	6
Z.KS.80028	M8x10	9,7	15	12	6
Z.KS.80036	M10x12	11,7	18	14	7
Z.KS.800366	M10x16	15,7	25	18	9
Z.KS.81265	M10x18	17,7	28	20	10
Z.KS.80176	M14x18	17,7	28	20	10
Z.KS.80077	M18x20	19,7	32	24	12
Z.KS.80242	M18x22	21,7	35	28	14
Z.KS.80093	M22x24	23,7	40	32	16

Scheiben DIN 6340

Plain washers DIN 6340

Joints DIN 6340

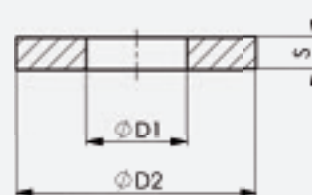

10

Bestell-Nr. Order no. Référence	Ausführung Version Type	D1	D2	S
Z.KS.82818	M6	6,4	17	2
Z.KS.82826	M8	8,4	23	4
Z.KS.82834	M10	10,5	28	4
Z.KS.82859	M14	15	40	5
Z.KS.82875	M18	19	45	6
Z.KS.82891	M22	23	50	8

Stiftschrauben DIN 6379

Studs DIN 6379

Boulon fileté DIN 6379



Bestell-Nr. Order no. Référence	Ausführung Version Type	B1	B2
Z.KS.84780	M6x50	9	30
Z.KS.81257	M8x40	11	20
Z.KS.81299	M10x50	13	25
Z.KS.84830	M10x80	13	50
Z.KS.81372	M14x63	17	32
Z.KS.84954	M18x125	23	75
Z.KS.86561	M18x160	23	100
Z.KS.81539	M22x160	31	100

Sechskantmuttern DIN 6330B

Fixture nuts DIN 6330B

Écrou hexagonal DIN 6330B

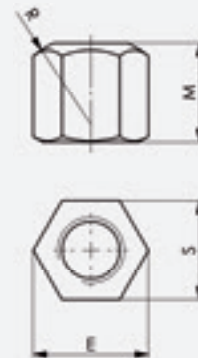

Bestell-Nr. Order no. Référence	Ausführung Version Type	E	M	R	S
Z.KS.82362	M6	11,05	9	9	10
Z.KS.82370	M8	14,40	12	12	13
Z.KS.82354	M10	17,80	15	15	16
Z.KS.82321	M14	23,40	21	20	21
Z.KS.82420	M18	30,10	27	24	27
Z.KS.82339	M22	37,70	33	30	34

10





Drehplatte

Swivel base
Plateau tournant

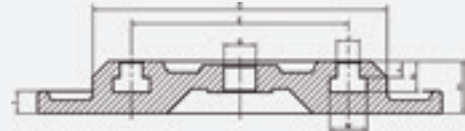
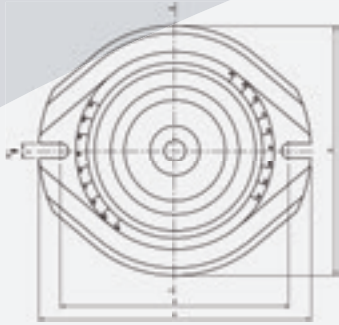

Bestell-Nr. Order no. Référence	Ausführung Version Type	A	B	C	D	E	F	G	H	I	J	K	L	M	N
Z.KS.HP402A	HP-40	233	220	167	197	125	12	16	25	25	11	0	7	19	15
Z.KS.HP502A	HP-50 / MP-50	272	260	212	239	160	18	16	33	33	14	0	10	26	22
Z.KS.HP602A	HP-60 / MP-60	327	322	255	286	201	20	16	37	37	18	0	12	32	23
Z.KS.HP802A	HP-80 / MP-80	410	410	305	370	240	20	16	46	46	18	0	15	36	27
Z.KS.AT413A	ATW-40	250	230	182	210	134	14	20	32	13,5	14	0	10	23,5	19
Z.KS.AT513A	ATW-50	275	257	212	239	163	14	20	36	13,5	14	0	10	23,5	19
Z.KS.AT613A	ATW-675 / ATW689	320	300	255	280	191	20	25	42	14,5	17,5	0	13	34	30
Z.KS.AT813A	ATW-810	400	380	320	356	250	20	30	49	20	17	0	15	32	33

Aufspannsätze

Clamping sets

Jeux se serrage



10

Bestell-Nr. Order no. / Référence	Ausführung Version / Type
Z.KS.ACK08	M8x1,25 - 10mm T-Nut
Z.KS.ACK10	M10x1,5 - 12mm T-Nut
Z.KS.ACK12A	M12x1,75 - 14mm T-Nut
Z.KS.ACK12B	M12x1,75 - 16mm T-Nut
Z.KS.ACK12C	M12x1,75 - 18mm T-Nut

Parallel-Unterlagen-Sätze

Set of parallel supports

Jeu de supports parallèles



Verwendung:

Parallelunterlagen finden vielseitige Verwendung als Hilfsmittel zum Spannen und Positionieren z.B. beim Schleifen, Fräsen, Erodieren, Messen und Anreissen.

Application:

Parallels are widely used for clamping and positioning, f.e. during grinding, milling, eroding, measuring and scribing.

Application:

Parallèles sont largement utilisés pour le serrage et le positionnement, p.e. pendant le meulage, fraisage, électroérosion, mesurage et traçage.

Bestell-Nr.	Ausführung
Order no. / Référence	Version / Type
91.12.150.1	14 x 2 - 150 x 10 x 14 (16,18,20,22,24,26,28,30,32,35,40,45,50)
91.12.150.2	14 x 2 - 150 x 8 x 14 (16,18,20,22,24,26,28,30,32,35,40,45,50)
91.12.200.3	14 x 2 - 200 x 10 x 14 (16,18,20,22,24,26,28,30,32,35,40,45,50)
91.13.100.1	9 x 2 - 100 x 4 x 10 (14,18,22,26,30,34,38,42)

Härte: HRC 55 - 62
Hardness: HRC 55 - 62
Dureté: HRC 55 - 62

Genauigkeit: 0,01mm
Accuracy: 0,01mm
Exactitude: 0,01mm

Parallelität: 0,005mm
Parallelism: 0,005mm
Parallélisme: 0,005mm

10

